



TL-3224 USER`S MANUAL



TL elektronik
Airport, Building 125, Hradec Kralove
503 41, Czech Republic

© Copyright 2003-2007
TL elektronik
All Rights Reserved

Except as expressly provided below, no part of this manual may be downloaded, transmitted, copied, reproduced, disseminated or stored in any storage medium, for any purpose without the express prior written consent of the TL elektronik company. Address your questions about the technical information to TL elektronik. Other information about sale, distribution should be directed to our exclusive distributors (see World Distributor list on our website).

Producer's address:
TL elektronik Inc.
Airport, Building 125,
503 41 Hradec Kralove, Czech Republic
Fax: +420 49 548 23 94 E-mail: info@tl-elektronic.com
Web Site Address: www.tl-elektronic.com

Please, send your e-mail address to customer@tl-elektronic.com to receive the latest information about software upgrade.

*Send your ideas to innovation@tl-elektronic.com.
We will evaluate your suggestion and provide an update.*

Record of revision

| Revision | Revision date | Description | ECO# | Insertion date | By |
|-----------------|----------------------|---------------------|-------------|-----------------------|-----------|
| A | 1/6/03 | Initial Release | --- | | |
| B | 1/7/04 | Language correction | 0001 | | |
| | | | | | |
| | | | | | |

Windows is registered trademark of Microsoft Corporation.
All trademarks and registered trademarks are acknowledged.
ScheckK® is registered trademark of TL elektronik.
iFamily® is registered trademark of TL elektronik.
sModern® is registered trademark of TL elektronik.
All information in this User's manual is subject to change without prior notice.

TABLE OF CONTENTS

| | |
|--|-----|
| 1. GENERAL DESCRIPTION | |
| 1.1. Introduction..... | 1-1 |
| 1.2. Instrument Description..... | 1-1 |
| 1.3. Technical Specifications..... | 1-2 |
| 1.4. Limited Conditions..... | 1-3 |
| 1.5. Limited Warranty..... | 1-3 |
| 1.6. Limited Operation..... | 1-3 |
| 2. INSTALLATION | |
| 2.1. Introduction..... | 2-1 |
| 2.2. Rack Consideration..... | 2-1 |
| 2.3. Installation into Panel..... | 2-1 |
| 2.4. Flaps and Gear Switch Installation..... | 2-1 |
| 2.5. Instrument Dimensions..... | 2-2 |
| 3. SYSTEM INTERCONNECT | |
| 3.1. Pin Function List..... | 3-1 |
| 3.2. TL-3224 Interconnects..... | 3-2 |
| 3.3. TL-3224 Connector and Pressure Hose Fitting Locations | 3-3 |
| 4. NAV-MENU DESCRIPTION | |
| 4.1. How to Control Instrument via NAV-MENU..... | 4-1 |
| 5. INSTRUMENT SETUP | |
| 5.1. First Instrument Turn-on..... | 4-1 |
| 5.2. Main Set-up Functions' Description..... | 5-1 |
| 5.3. How to select Air Speed Units..... | 5-2 |
| 5.4. How to select Air Speed Activation..... | 5-2 |
| 5.5. How to Select Warning and Alarm Limits of Air Speed..... | 5-2 |
| 5.6. How to select Never Exceeded Air Speed..... | 5-3 |
| 5.7. How to select Flaps check..... | 5-3 |
| 5.8. How to select Flaps Air Speed..... | 5-3 |
| 5.9. How to select Gear check..... | 5-3 |
| 5.10. How to select Gear check with Flaps..... | 5-4 |
| 5.11. How to select Gear input..... | 5-4 |
| 5.12. How to select Gear Air Speed..... | 5-4 |
| 5.13. User Button..... | 5-4 |
| 6. OPERATION MANUAL | |
| 6.1. Left Menu Description..... | 6-1 |
| 6.2. Right Menu Description..... | 6-2 |
| 6.3. How to Change Configuration..... | 6-3 |
| 6.4. Volume Level into Headphones | 6-3 |
| 6.5. Switch off Voice Warning Message..... | 6-3 |
| 6.6. Activation of Actual Speed Voice Message | 6-3 |
| 6.7. Displaying Maximum Air Speed Measured..... | 6-4 |
| 6.8. How to delete Maximum Air Speed Measured..... | 6-4 |
| 6.9. Display Signalization of Indication Switches Position..... | 6-4 |
| 6.10. Measuring Value out of Range..... | 6-4 |
| 7. SchecK® DESCRIPTION | |
| 7.1. Method of SchecK® for Storing into Memory..... | 7-1 |

1. GENERAL DESCRIPTION

1.1. INTRODUCTION

This manual describes the physical, mechanical and electrical features and functions of the TL-3224 AirSpeed meter.

1.2. INSTRUMENT DESCRIPTION

The TL-3224 provides complete air speed management. The instrument incorporates a high-precision sensor for air speed measurement.

The TL-3224 monitors opening and closing flaps and landing gear according to the speed and informs the user about the operation by an acoustic signalization.

The TL-3224 together with Intercom TL-2424 or TL-5624 Voice Module supplies acoustic information about actual speed. You can benefit from this feature especially when taking-off or landing. This increases the flying safety, as you do not need to watch the instrument during the process of take-off or landing.

The TL-3224 monitors exceeding the maximum speed limit, which could cause damage to the aircraft.

The TL-3224 checks all the measured values at two levels – at 1st level it gives warning to the pilot and at 2nd level it signalizes alarm limit (red line). In case the alarm warning was activated, next time the instrument is turned on it displays “Service” message and informs the user about the exceeded Airspeed.

The TL-3224 incorporates 20,000 line long-term memory and SchecK® memory (see page 7-1) in which the measured values are stored at sample rate 0.1 up to 60 seconds.

The User Button can be programmed in the Main Setup. It can be set up to quickly display any measured value or to quickly switch to another function.

It is possible to download the measured values from the instrument via the serial cable RS-232c into your PC.

1.3. TECHNICAL SPECIFICATIONS

The producer guarantees all stated technical parameters only when the instrument is installed by an authorized service or an aircraft manufacturer.

1.3.1 Physical Characteristics

| | |
|------------------------|---|
| Width | 71mm (2.795 inches) |
| Height | 67mm (2.637 inches) |
| Depth | 92mm (3.622 inches) including connectors with cover |
| Panel hole | 57mm (2.244 inches) diameter |
| TL-3224 Weight | 0.30 kg (0.66 lbs) |
| TL-3224 Harness | 0.05 kg (0.11 lbs) |

1.3.2 General Specifications

| | |
|------------------------------------|---|
| Operating Temperature Range | -20°C to +70°C |
| Humidity | 95% non-condensing |
| Altitude Range | 4600 meters max. |
| Power Range | 10.0 to 32.0 Volts |
| Max. Signalization | 30 Volts, 1 Ampere |
| Power Consumption | 0.15 Ampere @ 14 VDC without gear sensor |
| Backlight Consumption | 0.08 Ampere max when ext. power is used |
| Vibration | 5 to 500 Hz |
| Show Rate (LCD Refresh) | 0.5 second |

1.3.3 Long-term Memory and Communication

| | |
|---------------------------------|---|
| Storing Rate | 0.1 to 60 seconds user selectable |
| Memory Capacity | Scheck® method |
| Stored Values | Air Speed |
| Data Saved Endurance | 30 years |
| Rolling Memory life-time | 50 000 hours @ 0.1 second storing rate |
| Communication | RS-232c |
| Communication Speed | 38400 bps |

1.3.4 Landing Gear Switch

| | |
|--------------------------------|---|
| Landing Gear (positive) | Positive signal 3 to 15 Volts. Can be used Inductive sensor of PNP type or standard switch connected between input pins 13 and Aircraft Power. |
| Landing Gear (negative) | Input pin 9 connected to Aircraft Ground or standard switch connected between input pins 9 and 10. |

1.3.5 Instrument Measured Range / Resolution

| | |
|------------------------------------|--|
| Air speed | 20 to 350 km/h / 5 km (10.8 knots to 189 knots / 2.7 knots) Absolute maximum speed 500 km/h (270 knots) |
| Air speed (version EAS) | 20 to 510km/h / 5km (11knots to 275knots / 2.7knots) Absolute maximum speed 950 km/h (513 knots) |

1.4. LIMITED CONDITIONS

1.5. LIMITED WARRANTY

The TL elektronik company warrants this product to be free from defects in materials and manufacture for three years from the date of purchase. TL elektronik will, at its sole option, repair or replace any components that fail in normal use. Such repairs or replacement will be made at no charge to the customer for parts or labour. The customer is, however, responsible for any transportation costs. This warranty does not cover failures due to abuse, misuse, accident or unauthorized alteration or repairs.

THE WARRANTIES AND REMEDIES CONTAINED HEREIN ARE EXCLUSIVE AND IN LIEU OF ALL OTHER WARRANTIES EXPRESS OR IMPLIED OR STATUTORY, INCLUDING ANY LIABILITY ARISING UNDER ANY WARRANTY OF ENCHANT ABILITY OR FITNESS FOR A PARTICULAR PURPOSE, STATUTORY OR OTHERWISE. THIS WARRANTY GIVES YOU SPECIFIC LEGAL RIGHTS, WHICH MAY VARY FROM STATE TO STATE.

IN NO EVENT SHALL TL ELEKTRONIC BE LIABLE FOR ANY INCIDENTAL, SPECIAL, INDIRECT OR CONSEQUENTIAL DAMAGES, WHETHER RESULTING FROM THE USE, MISUSE, OR INABILITY TO USE THIS PRODUCT OR FROM DEFECTS IN THE PRODUCT. SOME STATES DO NOT ALLOW THE EXCLUSION OF INCIDENTAL OR CONSEQUENTIAL DAMAGES, SO THE ABOVE LIMITATIONS MAY NOT APPLY TO YOU.

To obtain warranty service, call the TL elektronik Customer Service (+420 49 548 23 92) for a returned merchandise tracking number. The unit should be securely packaged with the tracking number clearly marked on the outside of the package and sent freight prepaid and insured to a TL elektronik warranty service station. A copy of the original sales receipt is required as the proof of purchase for warranty repairs. TL elektronik retains the exclusive right to repair or replace the unit or software or offer a full refund of the purchase price at its sole discretion.

SUCH REMEDY SHALL BE YOUR SOLE AND EXCLUSIVE REMEDY FOR ANY BREACH OF WARRANTY.

1.6. LIMITED OPERATION

This product is not TSO approved as a flight instrument, therefore, the manufacturer will not be held responsible for any damage caused by its use.

All maximum or minimum airspeed limits set either by the manufactures or by the user cannot be used for flight operations on or beyond the boarder of the aircraft operational airspeed.

2. INSTALLATION

2.1 INTRODUCTION

Careful planning and consideration of the suggestions in this section are required to achieve the desired performance and reliability from the TL-3224.

2.2 RACK CONSIDERATION

Plan a location that gives the pilot complete and comfortable access to the entire keypad and is plainly visible from the pilot's perspective. Check that there is adequate depth for the rack in the instrument panel. Location is advised to be away from heating vents or other sources of heat generation.

2.3 INSTALLATION INTO PANEL

 **Connect the cables into the connector and use the connector cover. Secure the incoming leads to prevent their effect on the connector in the vertical direction.**

2.4 FLAPS AND GEAR SWITCH INSTALLATION

To fully utilize the warning system that monitors opening and closing flaps and landing gear operation, it is necessary to install indication switches on the aircraft. The indication switches will send information about flaps and landing gear position to the TL-3224 Airspeed meter.

When installing indication switch for the landing gear, make sure it is switched on when Gear-Down. If the landing gear switch is active in the Aircraft Power, connect it to the input no. 13 on the connector P3201. In case the landing gear switch is active in the Aircraft Ground, connect it to the input no. 9 on the connector P3201.

When installing the flaps switch, make sure it is switched on when the flaps are in take-off and also landing positions.

For Gear-Up status and Flaps DOWN status all the indication switches must be in the „OFF“ position.

Mounting Rack Dimension

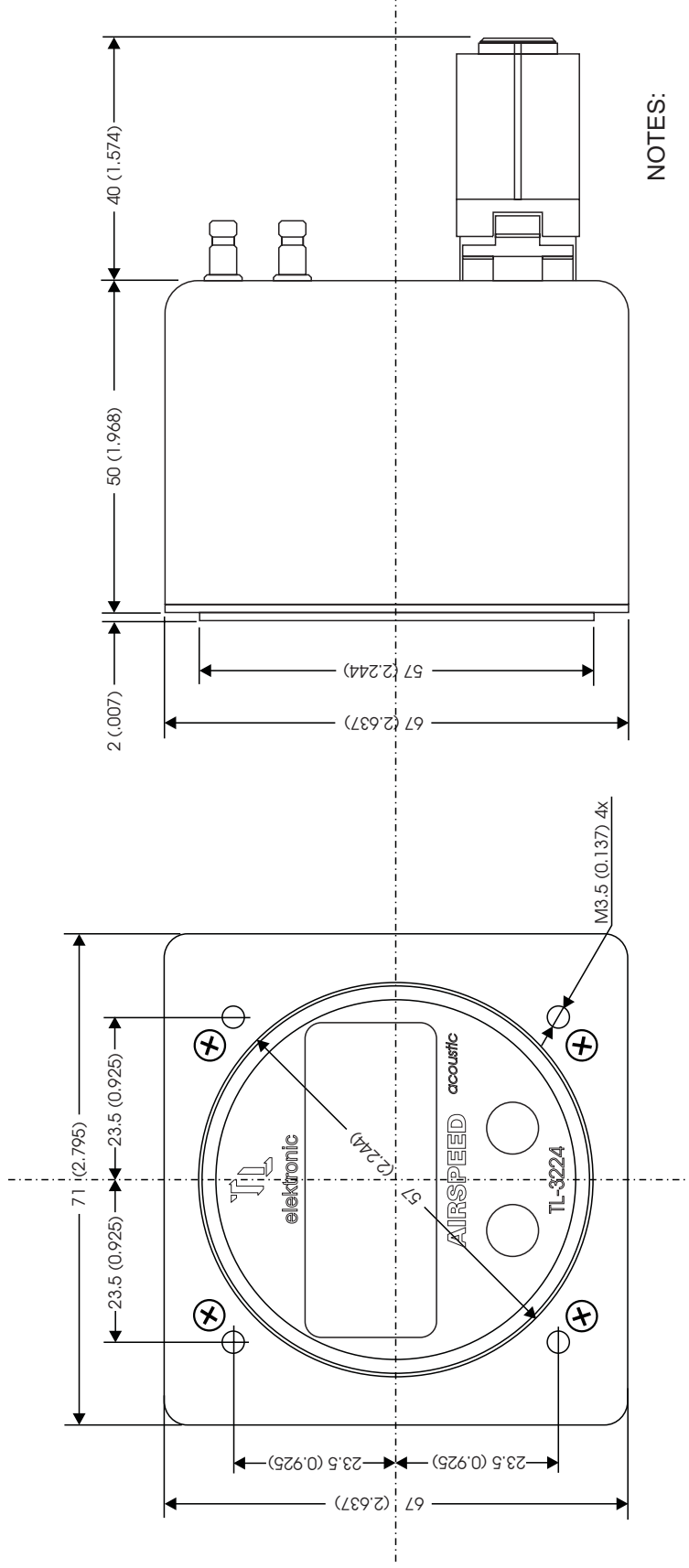

NOTES:

1. Dimension: mm (INCH)
2. Unit weight: 0.3 kg (0.66 lbs)
3. Mounting Rack & Hardware weight: 0.05 kg (0.11 lbs)

Figure 2. Rack Dimension

3.1 PIN FUNCTION LIST

| Pin | Pin Name | I/O |
|-----|--|-----|
| 1 | Take-off Flaps switch | In |
| 2 | Ground for Take-off Flaps switch | -- |
| 3 | Do not connect! | -- |
| 4 | Do not connect! | -- |
| 5 | Landing Flaps switch | In |
| 6 | Ground for Landing Flaps switch | -- |
| 7 | Aircraft power | In |
| 8 | Aircraft ground | -- |
| 9 | Gear-Down switch (active on aircraft ground) | In |
| 10 | Ground for Gear-Down switch | -- |
| 11 | Input for backlight | In |
| 12 | Internal source for backlight | Out |
| 13 | Gear-Down switch (active on aircraft power) | In |
| 14 | Ground for Gear-Down switch | -- |
| 15 | Input for User button | In |
| 16 | Ground for User button input | -- |
| 17 | Audio output | Out |
| 18 | Ground for Audio output | -- |
| 19 | iFamily® communication ISCL | I/O |
| 20 | iFamily® communication ISDA | I/O |
| 21 | Signalization unit | Out |
| 22 | Ground for PC communication (RS-232) | -- |
| 23 | RXD from PC (RS-232) | In |
| 24 | TXD to PC (RS-232) | Out |

Accessories Interconnect

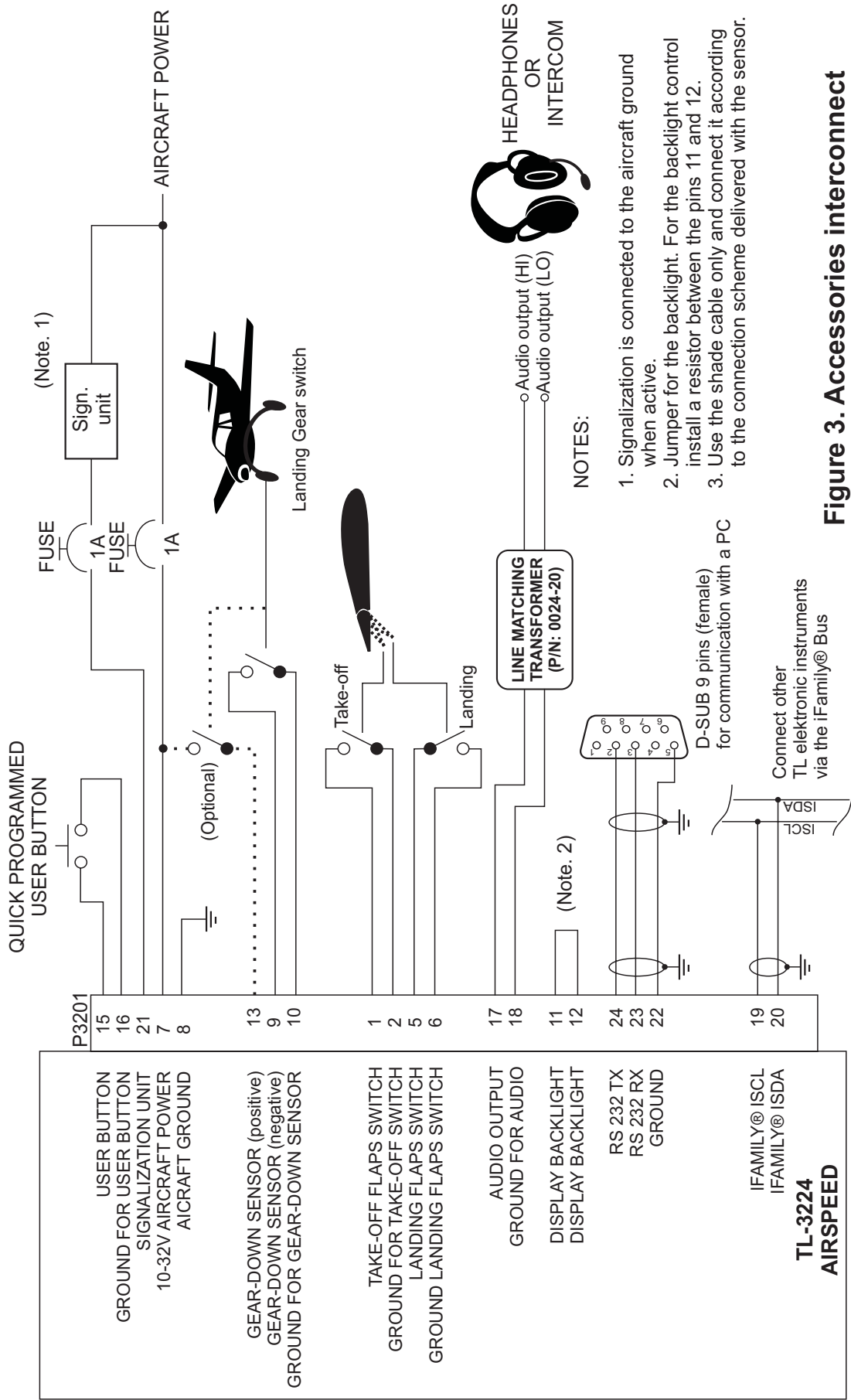
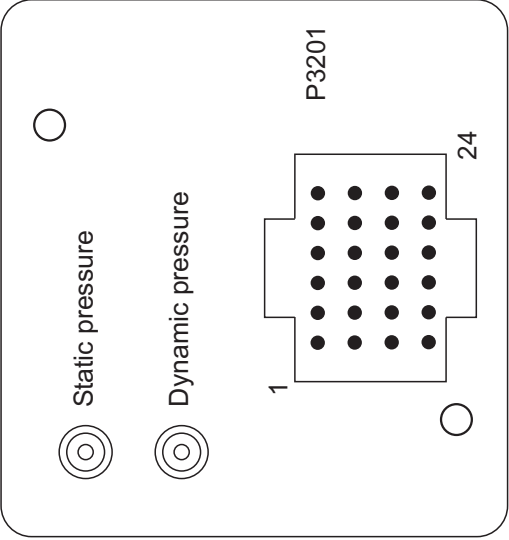

Figure 3. Accessories interconnect

TL-3224 USER'S MANUAL
P/N 18-3224-2003

Rear view of connector plate and pressure fitting



NOTES:

1. Secure the incoming leads to prevent their effect on the connector in the vertical direction.
2. Secure both hoses of the static and the complete (pitot) pressure. Any leakage or untightness could cause incorrect indications of other instruments.

Figure 5. Connectors locate

4. NAV-MENU DESCRIPTION

4.1 How to Control Instrument via NAV-MENU

There are black labels on the display. Each is affiliated to the left and the right button. Before pressing a button, read the information on the label. Its functions are different in every menu.

The left label is for the Left button.

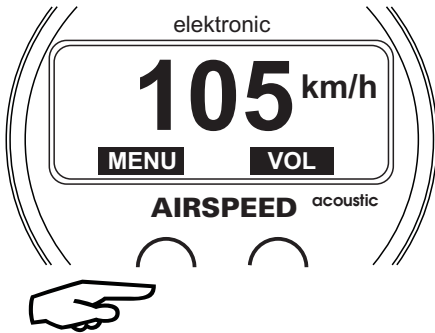

The right label is for the Right button.

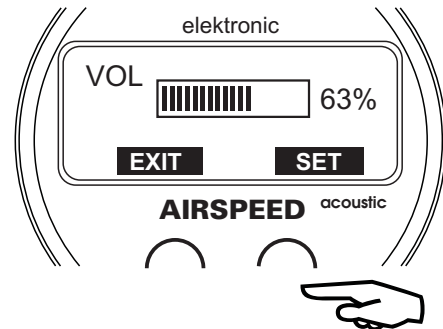

To store a value into the memory, press both buttons simultaneously. Release buttons when the setting arrows vanish.



5 INSTRUMENT SETUP

5.1 First Instrument Turn-on

Before the Airspeed meter starts to indicate you must do the basic setting of language, contrast, limits, etc. After the first turn-on of the instrument, the „FIRST SETUP“ message will show on the display. This set-up must be completed to continue.



5.2 Main Set-up Functions' Description

The table of the instrument configuration steps is shown below (Initial - firmware version 1.0).

| | | |
|----|-----------------------|--|
| 0 | LANGUAGE | Select your language for communication with the instrument. |
| 1 | DISPLAY CONTRAST | Select contrast of the display. |
| 2 | PASSWORD | Enter your password. |
| 3 | SPEED UNIT | Select your local unit for air speed. |
| 4 | SPEED ACTIVATE | Set the air speed that activates the signalization system. |
| 5 | WARNING MAX SPEED | Set the warning limit for the maximum AirSpeed. |
| 6 | ALARM MAX SPEED | Set the alarm limit for the maximum AirSpeed. |
| 7 | NEVER EXCEEDED SPEED | Set the limit for the Never Exceeded AirSpeed. |
| 8 | FLAPS CHECK | Select ON = to monitor opening and closing of flaps; select OFF = to switch off the monitoring. |
| 9 | MIN FLAPS SPEED | Set the minimum air speed when the flaps have to be opened. |
| 10 | MAX FLAPS SPEED | Set the maximum air speed when have to be closed. |
| 11 | GEAR CHECK | Select ON = to monitor UP and DOWN the landing gear; select OFF = to switch off the monitoring. |
| 12 | GEAR CHECK WITH FLAPS | Select ON = to monitor DOWN landing gear while opening flaps; select OFF = to switch off the monitoring. |
| 13 | GEAR INPUT | Select POSITIVE = if the landing gear switch is connected to input no. 13; select NEGATIVE = if the landing gear switch is connected to input no. 9. |
| 14 | MIN SPEED FOR GEAR | Set the minimum air speed when the landing gear has to be DOWN. |
| 15 | MAX SPEED FOR GEAR | Set the minimum air speed when the landing gear has to be UP. |
| 16 | USER BUTTON | Pre-set your button to these functions: SIGNAL. DEACTIVATE = deactivation of acoustic, voice and optical signalization; SHOW MAX VALUE = displaying the maximum AirSpeed reached. |
| 17 | VOICE WARNING | Enable or disable voice warning into your headphones. (Only with use of our Intercom TL-2424 or Voice Module) |
| 18 | INST. ON-LINE | Check the connected instruments from the TL elektronik iFamily® that are On-Line. |



All information on this page is subject to change without prior notice. Download the latest version of the manual from www.tl-elektronic.com and compare with you version of firmware.

5.3 How to select Air Speed Units

For selecting the Air Speed units, use the Select button in the Setup menu. The selected unit is shown inversely on the black background. When the unit has been selected, press the Continue button for storing and go to the next step of configuration.

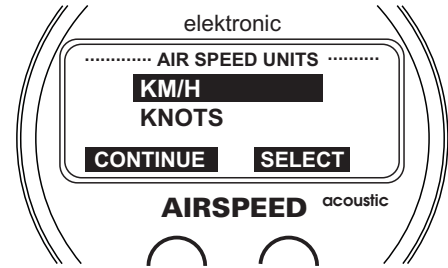

5.4 How to select Air Speed Activation

In this menu you can set the Air Speed, which activates the Control System. The Air Speed should correspond with the stalling speed of the plane in the way that the Control System is deactivated after landing and activated again after take off.

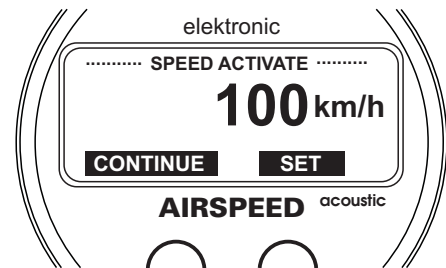

5.5 How to Select Warning and Alarm Limits of Air Speed

The maximum and minimum limit values can be set at two levels in the Set-up menu. The Warning message informs about the first exceeded level; the Alarm message informs about exceeding the second limit and activates recording into the SchecK® drawer. You can download all exceeded values from the instrument and analyze them on your PC.

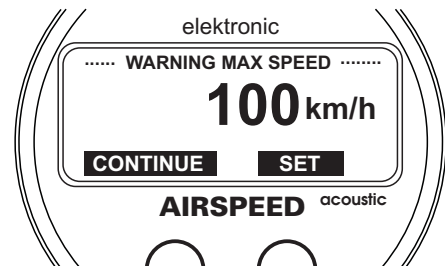

Before setting the maximum and minimum limits, check the limits of these values in the aircraft operation manual. Insert the limits stated in the aircraft operation manual in the Alarm menu. The Warning limits should be lower, so that the aircraft is operated safely.

⚠ The Warning limits activate signalization that informs you about exceeding the set AirSpeed limits. The Alarm limits activate signalization and, in addition, memory recording of the exceeded value, and also informs the pilot before the next flight that the safety limits set by aircraft manufacturer were exceeded.

⚠ If memory recording is de-activated, only the Warning limit signalization is active and no data is recorded into the SchecK® memory.

5.6 How to select Never Exceeded Air Speed

In this menu you can set the limits stated in the aircraft operation manual called Never Exceeded Speed. In this case the pilot is informed before the next flight that the safety limits set by the aircraft manufacturer were exceeded.

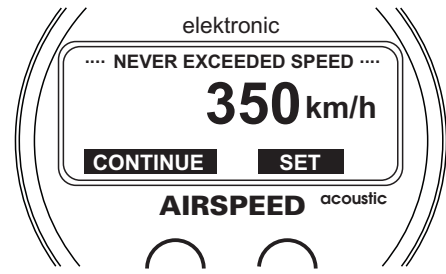

5.7 How to select Flaps check

In this menu you can turn on/off the signalization that informs you about the opened flaps at the high Air Speed and closed flaps at the low Air Speed. If you want to activate this function, select "ON". However, before you do that, check that all indication switches are installed and fully operational; see status of switches in section 6.9.

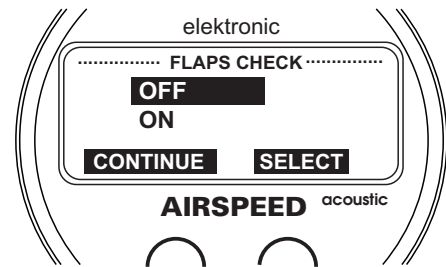

5.8 How to select Flaps Air Speed

In this menu you are able to set minimum air speed when the flaps have to be opened and maximum air speed when the flaps have to be closed. Set the limits according to the limits stated in the aircraft operation manual.

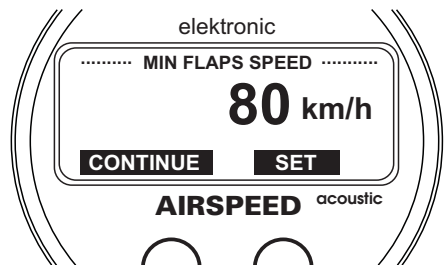

5.9 How to select Gear check

In this menu you can turn on/off the signalization for the DOWN landing gear at a high air speed and UP landing gear at a low air speed. If you want to activate this function, select "ON". However, before you do that, check that the gear indication switch is installed and fully operational; see status of switches in section 6.9.

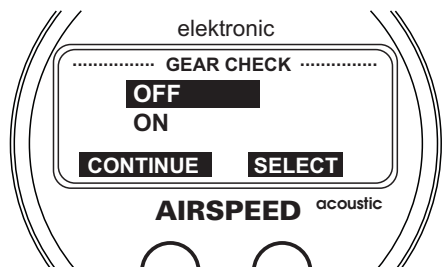

5.10 How to select Gear check with Flaps

In this menu you can turn on/off the signalization for opening the flaps when the landing gear is DOWN. If you want to activate this function, select “ON”. However, before you do that, check that all indication switches are installed and fully operational; see status of switches in section 6.9.

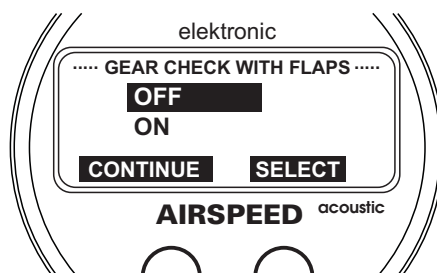

5.11 How to select Gear input

In this menu you can set position of the switch output while the landing gear is DOWN; the switch connected to Aircraft Ground or to Aircraft Power. Select POSITIVE if the landing gear switch is connected to input no. 13 or select NEGATIVE if the landing gear switch is connected to input no. 9.

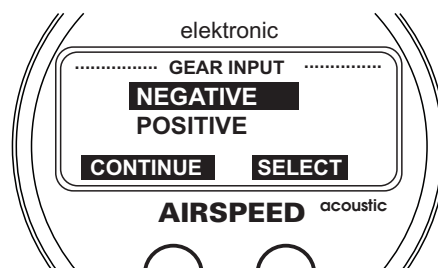

5.12 How to select Gear Air Speed

Set minimum speed at which the landing gear DOWN's and maximum speed at which the landing gear UP's. Set these values according to the limits stated in the aircraft operation manual.

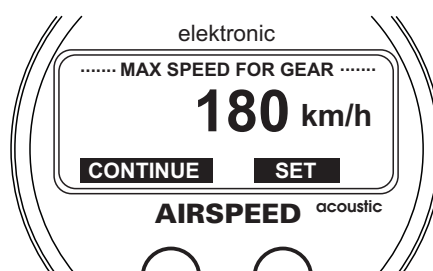

5.13 User Button

When pressed, the external User button allows you to program quick show or quick switch back to the selected menu. After releasing the button, you get back to the measured value indication. For example - if you have set SIGNALIZATION DEACTIVATE, immediately after pressing the button the acoustic signalization of the landing gear state or flaps state is deactivated.

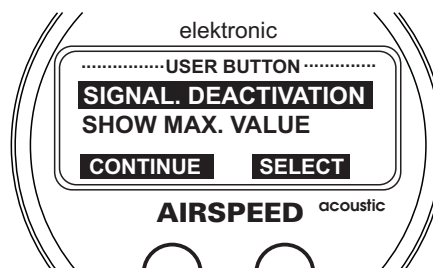

6. OPERATIONAL MANUAL

6.1. Left Menu Description

The left main menu shows the information about the airspeed and also you can there preset voice warning system etc.

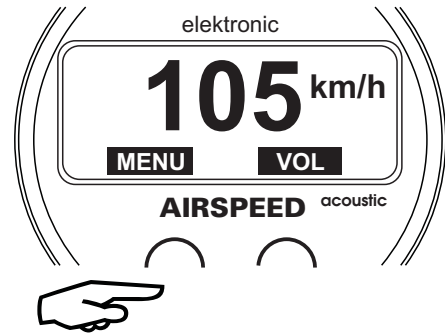

Left Menu (Initial firmware version 1.0)

| First | Second | Description |
|-----------|--------|---|
| VOICE WRN | | Voice Warning message |
| INF MSG | | Actual Speed Voice Message |
| | MAX | Long-term memory of the maximum air speed |
| | DELETE | Delete the long-term memory of the max. air speed |
| | EXIT | Exit from the second menu |

 All information on this page is subject to change without prior notice. Download the latest version of the manual from www.tl-elektronik.com and compare with you version of firmware.

6.1.1 Second Menu

The „OTHER“ dialog will show on the display after pressing the left button. If you press „YES“ in this dialog, the instrument will go to the second menu where you can get the information about the airspeed values from the long-term memory or about the time, during which the maximum airspeed was exceeded.

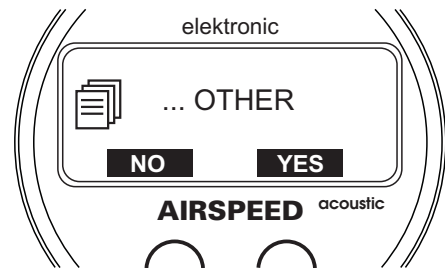

6.2 Right Menu Description

The right menu is used for the fast control.

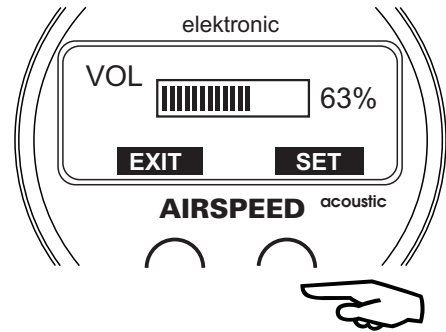

Right Menu (Initial firmware version 1.0)

| First | Second | Description |
|--------|--------|---------------------------------|
| VOLUME | | Volume level in your headphones |

! All information on this page is subject to change without prior notice. Download the latest version of the manual from www.tl-elektronic.com and compare with you version of firmware.

6.2.1 Exit from Right Menu

The instrument will automatically exit the right menu after 1 second.

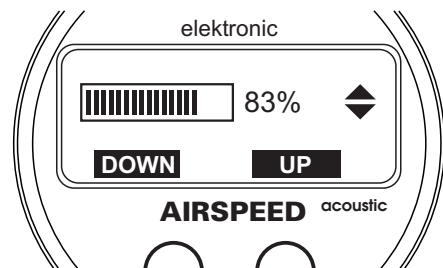

6.3 How to Change Configuration

If you want to change e.g. units or contrast, press and hold both buttons and turn the instrument on. The „Setup“ message will show on the display. Press „OK“ and go to the Instrument Setup.

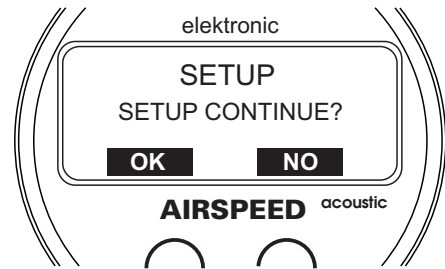

⚠ Note, that any unauthorized change of values in the Setup can cause defect of the instrument. An incorrect change of the calibration could endanger your life and the lives of your passengers.

6.4 Volume Level into Headphones

In this menu you can set the volume level for the headphones. If your headphones incorporate volume control, set the volume level in this menu to 100%, and then adjust it to the desired level by the volume control in the headphones.

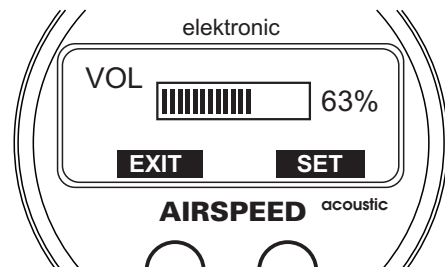

6.5 Switch off Voice Warning Message

You can temporarily switch off the voice warning signalization in the Main Menu. You can use this option in the case of not wanting to be disturbed by the signalization, e.g. performing low speed transit with DOWN landing gear. Then select OFF. The next time the instrument is switched on, it returns into the default setting and the signalization is active.



6.6 Activation of Actual Speed Voice Message

Air Speed Meter together with Intercom TL-2424 or Voice Module TL-5624 enables to inform the pilot about the actual speed. Pilot receives the speed message every three seconds in case that AIRSPEED in this menu is selected. In case you want to be informed only about warning status then select "LIM". In case you do not want to receive any voice messages, then select "OFF". The next time the instrument is switched on, it returns into the default setting and the signalization is active.

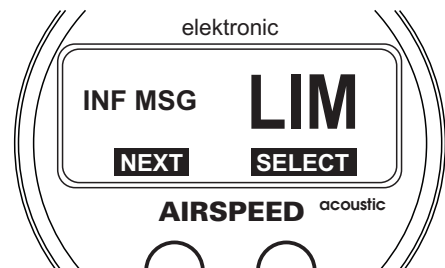

6.7 Display Maximum Air Speed

In this second menu you can display max. Air Speed. For this feature it is used a short-term memory, which you can delete at any time and start the measurement again, see section 6.8.

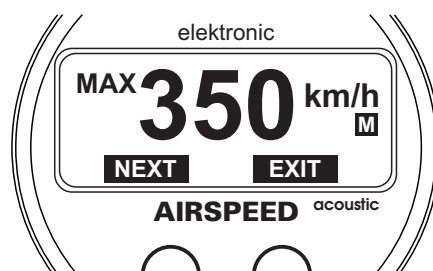

6.8 Delete Maximum Air Speed

In this second menu you can delete the measured maximum Air Speed. For this feature it is used a short-term memory, so you can delete it at any time by pressing YES button.

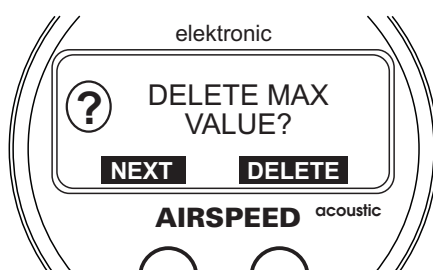

6.9 Display Signalization of Indication Switches Position

The position of each Flaps indication switch and Landing Gear indication switch is shown on the display with different symbols. Symbol [F] is for Flaps that are in landing or take off position. Symbol [G] is for DOWN Landing Gear.

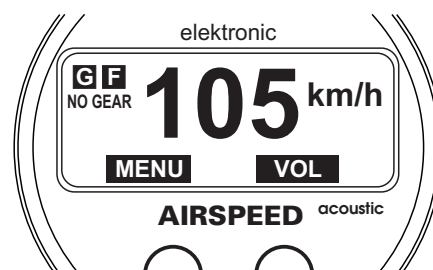

6.10 Measuring Value out of Range

When the measured air speed of the sensor is out of range, the [---] message will show on the display.

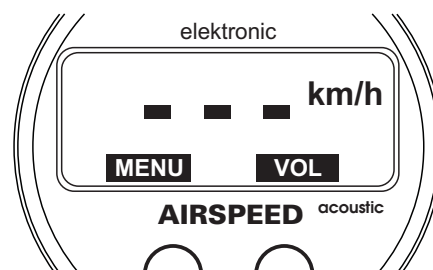

7.1 SchecK® memory description

The TL-3224 includes a 20,000 lines long-term memory and SchecK memory for storing of measured values in the 0.1 to 60 second sample rate. The measured data you can be downloaded via a standard PC serial cable RS-232 into a Laptop or Personal Computer.

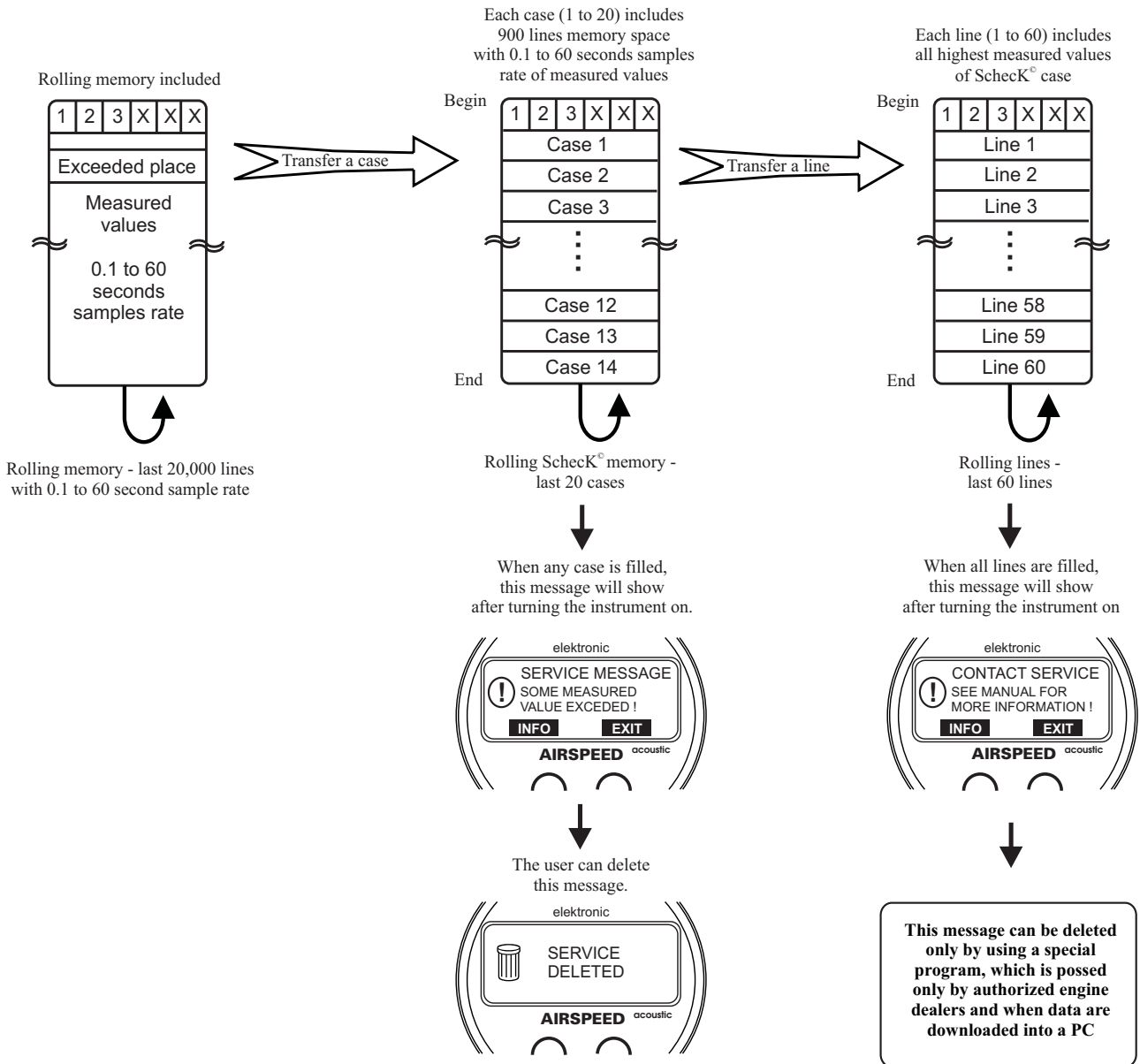

Cases 1 to 20 include 900 lines of exceeded limit values and engine hours when the values were exceeded.

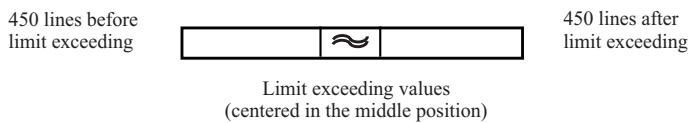

In this version it is possible to read last 20 exceeded records at total operational time.

This page intentionally left blank